

## Section Flatcutter-Disc Tool and Disc's Metrological Research

Prof. Dr. E.B. Isgandarzada<sup>1</sup>, G.N. Abbasova<sup>2</sup>, B.A. Abbasov<sup>3</sup>, S.V. Ahmadli<sup>4</sup>

Azerbaijan Technical University, Chair of Metrology and Standardization

**Abstract**— The small-sized sectional flatcarved-disc tool with the ability to carry out the process of spontaneous oscillations under the influence of the differential resistance of cultivated layer of soil is considered. This tool is designed for both tillage under The various crops, and for inter-row and inter-bush processing in orchards, vineyards, berry fields and nurseries. PS DMIS CAD ++ program was used to a metrology research of disc.

**Keywords**— disc battery, flatcutter-subsoilers, rotating frames, tolerance, concentricity.

### I. INTRODUCTION

Future trends include tillage research on the development and widespread use in the manufacture of machines and plants combined advanced technologies and technical means of minimizing, such as the use of subsoiler and chisel plows in combination with disc and tooth harrows, rollers, a loop-harrows and other tools of a new generation, ensuring high qualitative performance, decrease of metal and energy.

Minimal processing reduces the impact of machines and implements for soil and helps to preserve its fertility [1-4].

### II. INSTRUMENT'S CONSTRUCTIVE SCHEME, STRUCTURE AND SUPERIORITIES

The main difference of considered small-sized construction flatcarved-disc tool, intended for pre-processing of different crops, and mainly of inter-row orchards, vineyards and berry patches, is to hinge arrangement for turning frames (Figure) disc batteries and flatcarved-subsoiler [5].

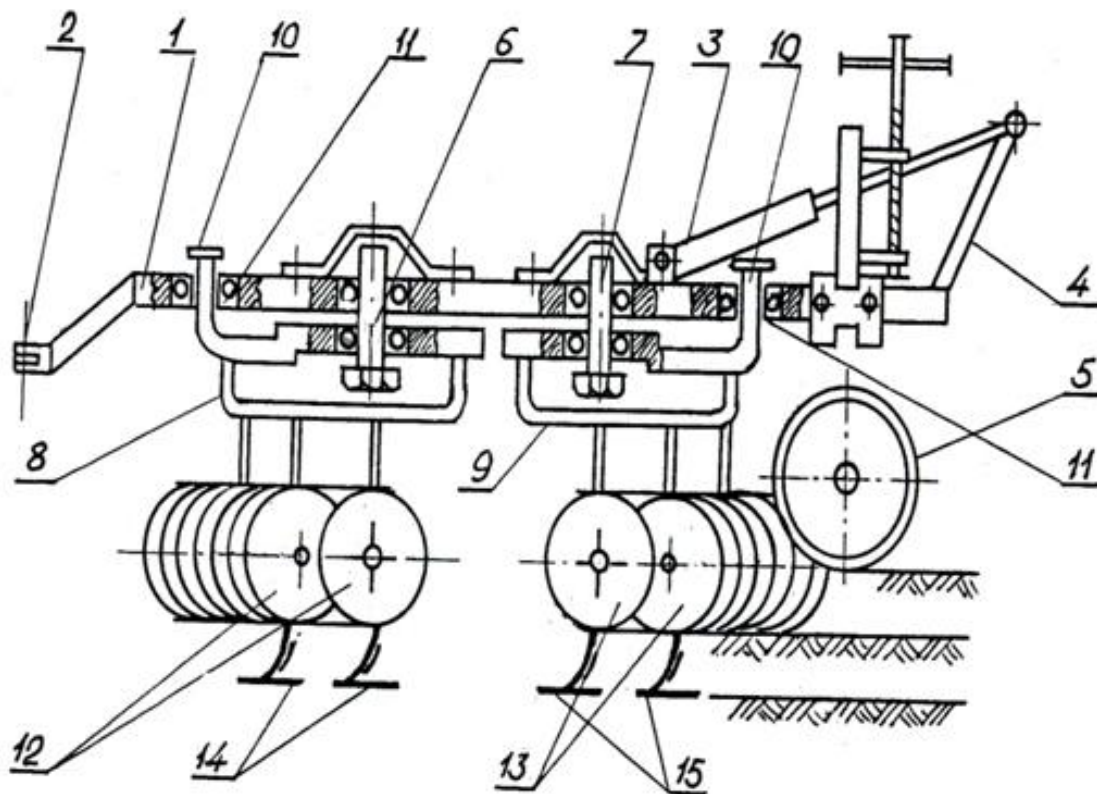

(A)

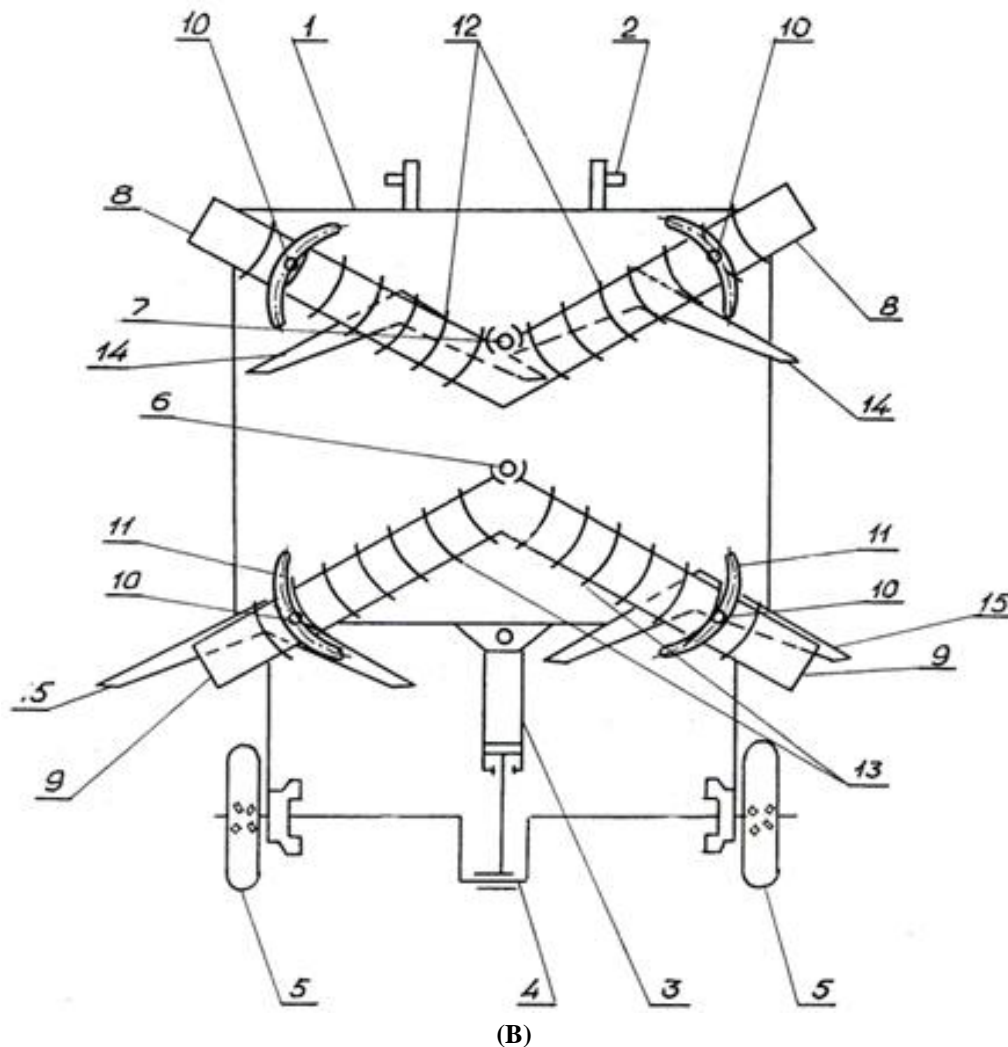

**FIGURE 1: STRUCTURAL LAYOUT**

The structural layout of the combined flatcarved-disc tool

1 - Frame 2 - Trailer 3 - cylinder lift and lower the gun, 4 - crank; 5 - jockey wheel, 6, 7 - the central hinge, 8, 9 - revolving frame, 10 - the carrier; 11 - copier fluctuations, 12, 13 - front and rear sections of a pair of disc batteries; 14, 15 - Front and rear pair of flatcarved deep-drilling paws.

In the front and middle part of the frame 1 (see Figure) along the longitudinal axis of symmetry are respectively mounted front and rear (central) joints 6 and 7, on the vertical axis are under the frame 1 fixed front and rear swing frames 8 and 9 horizontal movement. Following the central hinge 6 and 7 additional turning in the horizontal plane of the frame 8 and 9 at the ends are in the form of curved at a right angle vertically mounted drive 10 which in turn is planted in rolling bearings copiers 11. Sector of each cam 11 is restricted angle of  $30^\circ$ , corresponding schim amplitude of possible vibrations (as the soil resistance force) of the front and rear pair of working bodies 12, 13 and 14, 15 with the same angles solution batteries and plowshares legs 14, 15 is assumed to be  $148 \dots 150^\circ$  (Figure "b").

The technical process of the device is to convert the frame 1 from the transport position to the hydraulic cylinder 3 with a constant penetration facing unit deep-drilling pads 14, 15 and then drive batteries 12, 13 into the ground, and then under the influence of the resistance of the soil attributable on the working bodies of the front and back row, they make a forced oscillation at alternate and continuous change in the angle of attack clutches and drive batteries, taking the different phases of a limited fluctuations in the extreme points of the cams 11, all working parts 12, 13, 14, 15 in a counterclockwise direction arrow, then an intermediate phase equilibrium working medium of which (Figure "b") correspond to identical values of the angle of attack and the subsequent phase of working limits extreme vibrations in the clockwise direction.

The technological process of operation provide the improvement of the quality of tillage; stability of a longitudinal vertical plane of motion, preventing working bodies, lowering overall draft resistance and self-cleaning of the working bodies at the expense of the drive from the soil itself, self-cleaning plant debris from clogging.

In addition, the design of the device has a low metal content and significantly small longitudinal base, providing high maneuverability due to the small turning radius.

### III. THE PRINCIPLES OF THE INSTRUMENT METROLOGICAL RESEARCH

One of the condition for upgrading the quality of the product is about getting proper information about parameters of the finished product, characters and features. For getting right measurement information it should be provided the combination of measurements. All of these actions towards this process is called metrological support.

The goal and positions of metrological support are these:

- Providing of disc' high quality and production's automation levels and its management efficiency;
- Providing of disc' details' and aggregates' replacement;
- Increasing of research and constructor work, also experiment and effectiveness of tests;
- Increasing of efficiency using property values and energy resources;
- People's control and prevention to labor and housing conditions, protection of environment, evaluation of natural resources and for the rational using of them actions' effectiveness;
- Planning for the state testing and setting the rules for production;
- The verification of measuring instruments.





### IV. THE DISC'S METROLOGICAL RESEARCH WITH PS DMIS CAD ++













One of the most important issues of modern industry is product quality and increased production efficiency. Improving the quality of the product, the design of the product, production process and operation of the process is accompanied by numerous technical measurements. In all these cases the achievement of a high level of measurement, accuracy and quality of the product is overcome a lot of errors with respect to the measurement conditions. Hexagon product design and process plant, as well as the production process, but also for the operation of any of its geometrical dimensions of the product in 3D format (close to nano) which is capable of carrying high-precision measurements.

This research study at the section flatcutter-disc tool's disc' model of the instrument of Hexagon Metrology Tigo SF 05.06.05 PS DMIS CAD ++ program has been developed to investigate.

For it we should work on Solidworks, AutoCAD and other programs, also we should save it as "iges.", and add to PS DMIS CAD ++ program.











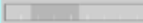

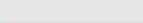
In this study the first phase of the acquisition of quality products is the design process of checking the accuracy of the measurements. On the model with using PS DMIS CAD ++ we programme these measurement processes. For it in the PS DMIS CAD ++ program we carry out these operations:

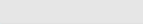
- 1) We activate PS DMIS CAD ++ program;
- 2) F10 (Parameter Settings)→Probe Options→OK – to ensure the accuracy of the results it is necessary to carry out the operation;
- 3) File→Import→IGES (we choose 3D model) → Process →OK;
- 4) Operation→Graphic Display Window→Transform (to co-ordinate axis of rotation of several degrees) →Rotate→Angle "-90", Rotate axis "Z axis" → Apply → OK
- 5)   Auto Vector Point→  Measure Now Toggle→6 point over model - 3:2:1/Z:X:Y →Create
- 6) Ctrl+Alt+A(Alignment Utilities)→Iteravite Alignment →Level -3:Pnt1/Pnt2/Pnt3→Select→ →Rotate-2: Pnt4/Pnt5→Select→Origin-1:Pnt6→Select→Meas all always→OK (Measure All iter align features now? - No)→OK
- 7) F10→Clearance Plane→Axis: ZPLUS→Value: 50→Clearance planes active (ON)  → Apply→OK
- 8)  Mode/DCC

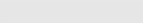
- 9)  Auto Circle (CIR 1) →  Measurement Strategies → Adaptive Concentric Circle Scan →  $\delta$ Size;  $\delta$ Location;  $\delta$ Form → Surface Type-Machined → Create
- 10)  Auto Circle (CIR 2) → Create
- 11)  Auto Circle (CIR 3) → Create
- 12)  Auto Circle (CIR 4) → Create
- 13)  Constructed Line → CIR 1:CIR 3 → LIN 1 → Create
- 14)  Constructed Line → CIR 2:CIR 4 → LIN 2 → Create
- 15)  Distance → Line1-Line2 → Relationship → To Y axis → Create
- 16)  Paralelism → LIN1:LIN2 → Create
- 17)  Circularity Dimension → CIR 1 → Create
- 18)  Circularity Dimension → CIR 2 → Create
- 19)  Concentricity Dimension → CIR 2:CIR 3 → Create

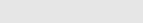
**CONCLUSION**

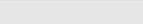
- 20) View → Path Lines → It shows the direction of programming which was fulfilled above.
- 21) Operation → Graphic Display Window → Callision Detection → Up to this point on the basis of programming measurements on the model is carried out automatically.
- 22) View → Report Window

podmis		PART NAME : SECTION FLATCUTTER-DISC TOOL					July 12, 2016	16:29
		REV NUMBER :	SER NUMBER :	STATS COUNT : 1				
	MM	DIST1 - LIN1 TO LIN2 (YAXIS)						
AX	MEAS	NOMINAL	+TOL	-TOL	DEV	OUTTOL		
M	25.393	25.400	0.010	0.010	-0.007	0.000		
	MM	PARL1 - LIN1 TO LIN2						
AX	MEAS	NOMINAL	+TOL	-TOL	DEV	OUTTOL		
M	0.007	0.000	0.010	0.000	0.007	0.000		
	MM	CONCEN1 - CIR1 TO CIR 4						
AX	MEAS	NOMINAL	+TOL	-TOL	DEV	OUTTOL		
M	0.035	0.000	0.010	0.000	0.035	0.025		
	MM	CIRTY1 - CIR1						
AX	MEAS	NOMINAL	+TOL	-TOL	DEV	OUTTOL		
M	0.054	0.000	0.010	0.000	0.054	0.044		
	MM	CIRTY2 - CIR2						
AX	MEAS	NOMINAL	+TOL	-TOL	DEV	OUTTOL		
M	0.014	0.000	0.010	0.000	0.014	0.004		
	MM	CIRTY3 - CIR3						
AX	MEAS	NOMINAL	+TOL	-TOL	DEV	OUTTOL		
M	0.014	0.000	0.010	0.000	0.014	0.004		
	MM	CIRTY4 - CIR4						
AX	MEAS	NOMINAL	+TOL	-TOL	DEV	OUTTOL		
M	0.054	0.000	0.010	0.000	0.054	0.044		

**REFERENCES**

- [1] E.B. Isgandarzada, N.K. Ismayilov, F.H. Hajiyev. Metrology, standartization and certification basics // Baku. "Vector". 2015. 669 p.
- [2] E.B. Isgandarzada. Modern combined tillage machines // Hannover. 2014. 300 p.
- [3] Sineokov G.N. Designing tillers / "Mechanical engineering". – M., 1995.
- [4] E.B. Isgandarzada. Technology and equipment for primary tillage // Baku, "Elm". 2010.
- [5] <http://hexagonmi.com/>
- [6] E.B. Isgandarzada. Tillage machines with active working body // The Strategies of Modern Science Development. II International scientific-practical conference/ 4-5 June 2013. Proceedings.Science Book Publishing House Yelm, Washington, USA, 2013. p. 15-17
- [7] <http://hexagonmi.com/products/coordinate-measuring-machines/accessories-for-cmms/tibox-enclosure-for-tigo-sf-cmm>