

Mathematical Analysis and Practical Applications of a Serial-Parallel Robot with Delta-Like Architecture

Chen-Yu Tzou¹, Min-Jie Hsu², Jing-Zhe Jian³, Yi-Hsing Chien⁴, Wei-Yen Wang^{5*},
Chen-Chien Hsu⁶

Department of Electrical Engineering, National Taiwan Normal University, Taiwan, R.O.C.
Corresponding author. TEL: +886-2-77343536; E-mail address: wywang@ntnu.edu.tw

Abstract—Delta robot is a mechanical design in a kind of parallel type. It is moved by three groups of power structures on the platform of active arms and passive arms led by the end of the platform equipped with the fourth axis at the end of the structure. In this paper, the serial-parallel design of a modified delta robot is proposed, which SolidWorks is employed for designing the mechanics. Forward and inverse kinematics are analyzed to establish the robotic arms, and the wiring hardware system is used to control the motors. To enhance the accuracies of the outputs of the motors, we employ the spherical bearings instead of the traditional ball joints. To verify the performances of the proposed designed delta robot, various tasks are introduced including drawing, playing dominos, objects classification based on image processing, and so on.

Keywords—Robotic arm, delta robot, forward and inverse kinematics, multi-axis robot control.

I. INTRODUCTION

In the early 1980s, Delta robot was invented by R. Clavel [1]. It is coupled with three axis' tandem arms at the end of the platform [2-6]. The advantages of designing so is that each single motor shared the loads in parallel mechanical arm so that it can reduce the wattage [7-11]. Moreover, delta robot is a parallel closed chain designed, and thus the overall rigidity of the machine is stronger and the inertia of movements are smaller as well [12-16]. However, besides the favorable advantages, it is actually difficult to have dynamic errors and cumulative errors, which could lead to inaccuracy results for the overall performances.

Therefore, emphasizing the advantages of serial and parallel institutions while simultaneously maintaining both stabilities and accuracies of the delta robot performances is a critical issue [17, 18] to be concerned. The previous article [17] was focused on the development of mechanism with hybrid kinematic structure called Trivariant. The trajectory can be controlled manually or automatically during the computer simulation. U. Thomas et al. [18] developed a unified notation for serial, parallel, and hybrid kinematic structures. With the extended DH-parameters, users were able to describe spherical, cardan, cylindrical, rotational, and prismatic joints following the well-known intuitive notation. However, only the simulation results were presented to verify the effectiveness. To address the above-mentioned problems, we developed a novel serial-parallel hybrid design of delta robot, which aim to avoid the drawbacks of both the dynamic errors and cumulative ones.

The design of a modified delta robot can briefly divided into two parts in terms of hardware and software systems. Considering the hardware system, it can be further subdivided into three parts including mechanical design, wiring and assembling. We use the software SolidWorks to design and simulate the overall mechanical structures and its kinematic movements by using large mechanical disassembly techniques. Then, the software system can also be further divided into the kinematic model, motor control, image processing and algorithms in projects. A modular package involving control is developed to speed up the overall computational time. To verify the system, several complex tasks are introduced to challenge the stabilities and reliabilities of the proposed delta robot system, including drawing, playing dominos, and objects classification based on image processing, and so on.

The remainder of this paper is organized as follows. Section II gives a mathematical analysis of the delta robot. Section III presents the design of both hardware and software systems of the proposed delta robot. Section IV presents the experimental results to verify the performances of the proposed system. Discussions of the proposed delta robot is given in Section V, and the conclusion of this paper is introduced in Section VI.

II. MATHEMATICAL ANALYSIS

To design a delta robot, its inverse and forward kinematics [19, 20] must be analyzed before we decide the position control of the under-platform and each axis servo motor feedback control. First, we analyze the inverse kinematics of the delta robot. Before starting to build a mathematical model, we need to simplify the mechanical system of a delta robot as proposed in [1].

According to the overall geometric model as proposed in [19], assumptions are given for the features of the size of the mechanical structure. Assume that $\Delta A_1A_2A_3$ be the regular triangles which lengths of the sides are f , and the centroid is the origin of the three-dimensional coordinates; $\Delta A_4A_5A_6$ also is a regular triangle with its length of side is θ and the centroid is a known position $E_1(x_0, y_0, z_0)$. Two normal vectors of the two regular triangles are mutually parallel, and both $\overline{A_1F_1}$, $\overline{A_4E'_1}$ are parallel with y axis, respectively. There are three axis, $\overline{F_1J_1}$, $\overline{F_2J_2}$ and $\overline{F_3J_3}$ on the upper arm of the delta robot, in which the lengths are r_f equally. The three under arms, denoted by $\overline{J_1E'_1}$, $\overline{J_2E'_2}$ and $\overline{J_3E'_3}$, have corresponding lengths of r_e , whereas F_n , J_n and the origin are coplanar ($n=1, 2, 3$). With the aforementioned assumptions, we can use the inverse kinematics theorem from a known under-platform's position $E_1(x_0, y_0, z_0)$ to obtain the value of each angle θ_n (vector angle of $\overline{A_nF_n}$ and $\overline{F_nJ_n}$, $n=1, 2, 3$) of each axis motor that connects the upper arm.

Coordinates $F_1\left(0, \frac{-f}{2\sqrt{3}}, 0\right)$ and $E'_1(x_0, y_0 - \frac{e}{2\sqrt{3}}, z_0)$ can be obtained easily by the overall geometric model [19]. Let $P_0 = y_0 - \frac{e}{2\sqrt{3}}$, $P_1 = \frac{-f}{2\sqrt{3}}$, we set $J_1(x_{j1}, y_{j1}, z_{j1})$ as the intersection of a circle (With F_1 as the center, r_f as the radius.) and sphere (With E'_1 as the sphere center, r_e as the radius.), and J_1 at yz -plane. Therefore, the following equations can be derived to obtain the coordinate $J_1(x_{j1}, y_{j1}, z_{j1})$.

$$x_{j1} = 0 \quad (1)$$

$$x_{j1}^2 + (y_{j1} - P_1)^2 + z_{j1}^2 = r_f^2 \quad (2)$$

$$(x_{j1} - x_0)^2 + (y_{j1} - P_0)^2 + (z_{j1} - z_0)^2 = r_e^2 \quad (3)$$

The subtraction of (3) and (2) results in the value of y_{j1} related to z_{j1} ,

$$(2y_{j1} - (P_0 + P_1))(P_0 - P_1) + (2z_{j1} - z_0)z_0 = r_f^2 - r_e^2 + x_0^2 \quad (4)$$

Simplifying (4) and let a and b as the two constants of the linear equations, and the coefficient y_{j1} can be expressed as follows,

$$z_{j1} = \frac{r_f^2 + x_0^2 + P_0^2 + z_0^2 - P_1^2 - r_e^2}{2z_0} + \frac{P_1 - P_0}{z_0} y_{j1} = a + by_{j1} \quad (5)$$

Substitute (5) to (2), we can derive,

$$y_{j1} = \frac{(P_1 - ab) \pm \sqrt{(P_1 - ab)^2 - (1 + b^2)(P_1^2 + a^2 - r_f^2)}}{1 + b^2} \quad (6)$$

If y_{j1} is a real number, it represents a circle and a sphere intersecting at two points. Based on the physical features of the delta robot, lesser value of y_{j1} can be obtained as shown in (7).

$$y_{j1} = \frac{(P_1 - ab) - \sqrt{(P_1 - ab)^2 - (1 + b^2)(P_1^2 + a^2 - r_f^2)}}{1 + b^2} \quad (7)$$

Finally, substitute y_{j1} into (5) to obtain the value of z_{j1} . Then we can solve $\theta_1 = \sin^{-1}\left(\frac{z_{j1}}{r_f}\right)$.

The methods of obtaining θ_2 and θ_3 are actually similar to θ_1 . Because the geometric properties do not change with the coordinate transformations, we can use rotation matrix as shown in (8) to rotate Cartesian-coordinate system along the z axis clockwise or counterclockwise in 120° .

$$E'_n[x'_0, y'_0, z'_0]^T = \begin{bmatrix} \cos\theta & \sin\theta & 0 \\ -\sin\theta & \cos\theta & 0 \\ 0 & 0 & 1 \end{bmatrix} \begin{bmatrix} x_0 \\ y_0 \\ z_0 \end{bmatrix} \tag{8}$$

Thus, (1)-(3) are rewritten as the generalized equations expressed as follows.

$$x_{jn} = 0 \tag{9}$$

$$x_{jn}^2 + (y_{jn} - P_1)^2 + z_{jn}^2 = r_f^2 \tag{10}$$

$$(x_{jn} - x'_0)^2 + (y_{jn} - P'_0)^2 + (z_{jn} - z'_0)^2 = r_e^2 \tag{11}$$

Because $P'_0 = y'_0 - \frac{e}{2\sqrt{3}}$, (12), (13) can be obtained and thus result in (14).

$$z_{jn} = \frac{r_f^2 + (x'_0)^2 + (P'_0)^2 + (z'_0)^2 - P_1^2 - r_e^2}{2z'_0} + \frac{P_1 - P'_0}{z'_0} y_{jn} = a' + b' y_{jn} \tag{12}$$

$$y_{jn} = \frac{(P_1 - a'b') - \sqrt{(P_1 - a'b')^2 - (1 + (b')^2)(P_1^2 + (a')^2 - r_f^2)}}{1 + (b')^2} \tag{13}$$

$$\theta_n = \sin^{-1} \sin^{-1}\left(\frac{z_{jn}}{r_f}\right) \tag{14}$$

In the above three equations, it is assumed that $n=1, 2, 3$, θ is substituted into the corresponding degrees $0^\circ, 120^\circ, -120^\circ$. Finally, when the position of the under-platform E_1 is known, the angles of the upper arms $\theta_1, \theta_2, \theta_3$ are generated by the three-axis motors.

As for the delta robot forward kinematics theory, it is actually opposite to inverse kinematic. From a known angles θ_n ($n = 1, 2, 3$) of the three-axis upper arms, we can unify the coordinate system as proposed in [19], and then calculate the space coordinates of J_1, J_2 and J_3 as shown in (15) by the rotation matrix as mentioned before.

$$J_n[x_{jn}, y_{jn}, z_{jn}]^T = \begin{bmatrix} \cos\theta & \sin\theta & 0 \\ -\sin\theta & \cos\theta & 0 \\ 0 & 0 & 1 \end{bmatrix} \begin{bmatrix} 0 \\ -\left(\frac{f}{2\sqrt{3}} + r_f \cos\theta_n\right) \\ r_f \sin\theta_n \end{bmatrix} \tag{15}$$

where $n=1, 2, 3$. θ is substituted into the corresponding degrees of $0^\circ, 120^\circ, -120^\circ$.

Assume that the solution of the center position coordinate of the under-platform is $E_1(x_0, y_0, z_0)$, we can use $\overline{J_1 E'_1} = \overline{J_2 E'_2} = \overline{J_3 E'_3} = r_e$ to write the following equations.

$$(x_0 - x_{j1})^2 + \left(y_0 - \frac{e}{2\sqrt{3}} - y_{j1}\right)^2 + (z_0 - z_{j1})^2 = r_e^2 \tag{16}$$

$$(x_0 + \frac{1}{4}e - x_{j2})^2 + (y_0 + \frac{e}{4\sqrt{3}} - y_{j2})^2 + (z_0 - z_{j2})^2 = r_e^2 \quad (17)$$

$$(x_0 - \frac{1}{4}e - x_{j3})^2 + (y_0 + \frac{e}{4\sqrt{3}} - y_{j3})^2 + (z_0 - z_{j3})^2 = r_e^2 \quad (18)$$

where the constants can be expressed by i_0, i_1, \dots, i_8 ,

$$\begin{bmatrix} i_0 & i_1 & i_2 \\ i_3 & i_4 & i_5 \\ i_6 & i_7 & i_8 \end{bmatrix} = \begin{bmatrix} x_{j1} & \frac{e}{2\sqrt{3}} + y_{j1} & z_{j1} \\ -\frac{1}{4}e + x_{j2} & -\frac{e}{4\sqrt{3}} + y_{j2} & z_{j2} \\ \frac{1}{4}e + x_{j3} & -\frac{e}{4\sqrt{3}} + y_{j3} & z_{j3} \end{bmatrix} \quad (19)$$

Then, subtracting (16) from (17) and (17) from (18), respectively, we can get a coordinate of (x_0, y_0, z_0) which is the parameter equation with t . Among $t \in \mathfrak{R}$, $\alpha = \frac{1}{2}(i_3^2 - i_0^2 + i_4^2 - i_1^2 + i_5^2 - i_2^2)$, and $\beta = \frac{1}{2}(i_6^2 - i_3^2 + i_7^2 - i_4^2 + i_8^2 - i_5^2)$.

$$x_0 = [(i_4 - i_1)(i_8 - i_5) - (i_7 - i_4)(i_5 - i_2)]t + \frac{\alpha(i_7 - i_4) - \beta(i_4 - i_1)}{(i_3 - i_0)(i_7 - i_4) - (i_6 - i_3)(i_4 - i_1)} \quad (20)$$

$$y_0 = [(i_5 - i_2)(i_6 - i_3) - (i_8 - i_5)(i_3 - i_0)]t + \frac{\beta(i_3 - i_0) - \alpha(i_6 - i_3)}{(i_3 - i_0)(i_7 - i_4) - (i_6 - i_3)(i_4 - i_1)} \quad (21)$$

$$z_0 = [(i_3 - i_0)(i_7 - i_4) - (i_6 - i_3)(i_4 - i_1)]t \quad (22)$$

Finally, substituting (20), (21), and (22) to (16), the value of t can be solved. Because under-platform center position must be under the xy -plane, the value of t leads to $z_0 \leq 0$, which is the solution of the position $E_1(x_0, y_0, z_0)$ of the forward kinematics.

III. THE PROPOSED SYSTEM ARCHITECTURE

We will divide the proposed system architecture into two parts, including the introduction of the proposed system architecture and system performance.

3.1 System Architecture

The system architecture in this paper can be divided into software, hardware and mechanical systems, as introduced in the followings.

3.1.1 Software system

As shown in Fig. 1, several buttons are designed for each stage, status monitor of the three motors, and a real-time video surveillance in the layer of UI. By pushing the button, the strategy of each stage leads to different ways of executing the inner functions of AX, CSBL, camera control, movement derivations. The software control flow chart as shown as Fig. 2, in order to enhance the program effectiveness, we use multiple threads to implement parallel task processing. The main process is user interface, which can control robot arm and refresh robot status in real-time. And then we also configure individually different threads into kernel computing, motor control and image processing.

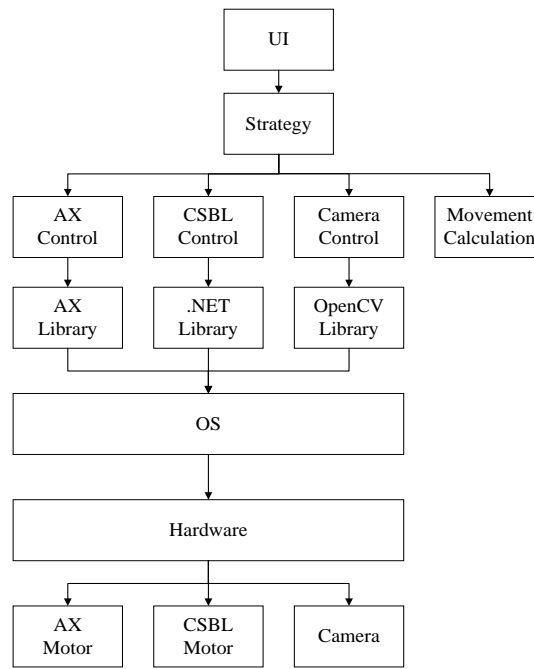

FIG. 1. THE ARCHITECTURE OF SOFTWARE SYSTEM.

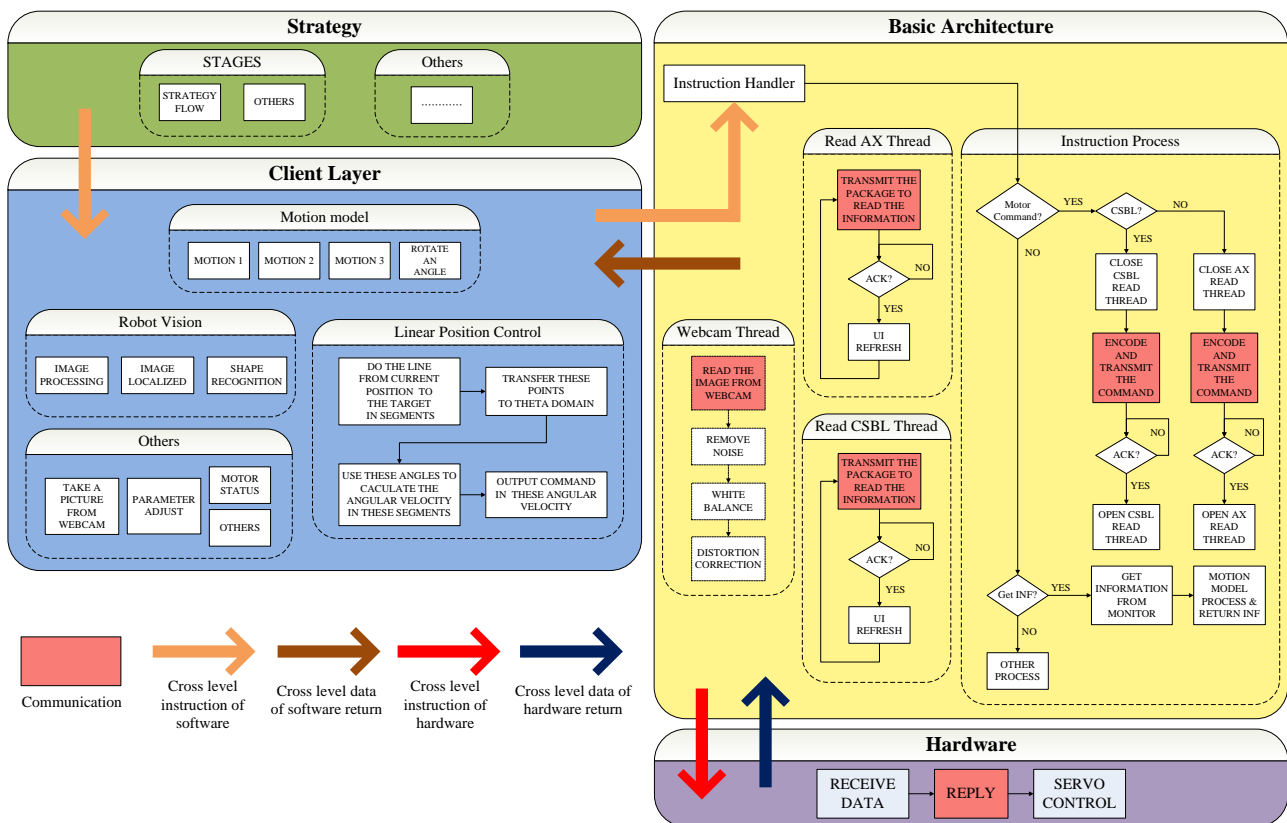

FIG. 2. THE SOFTWARE CONTROL FLOW CHART.

3.1.2 Hardware system

The wiring diagram for the three motors of the mechanical arms are shown in Fig. 3. Using the methods of hardware wiring, overload, stop, and reset basic actions can be achieved. The green light is used to monitor whether the motors are correctly functioning, while the red light is used to alert the motors inside the mechanical arm as long as overloading problem occurs.

The yellow lights are used to monitor whether each motor are overloaded and the EMS button is to cut off the power if something emergently happens.

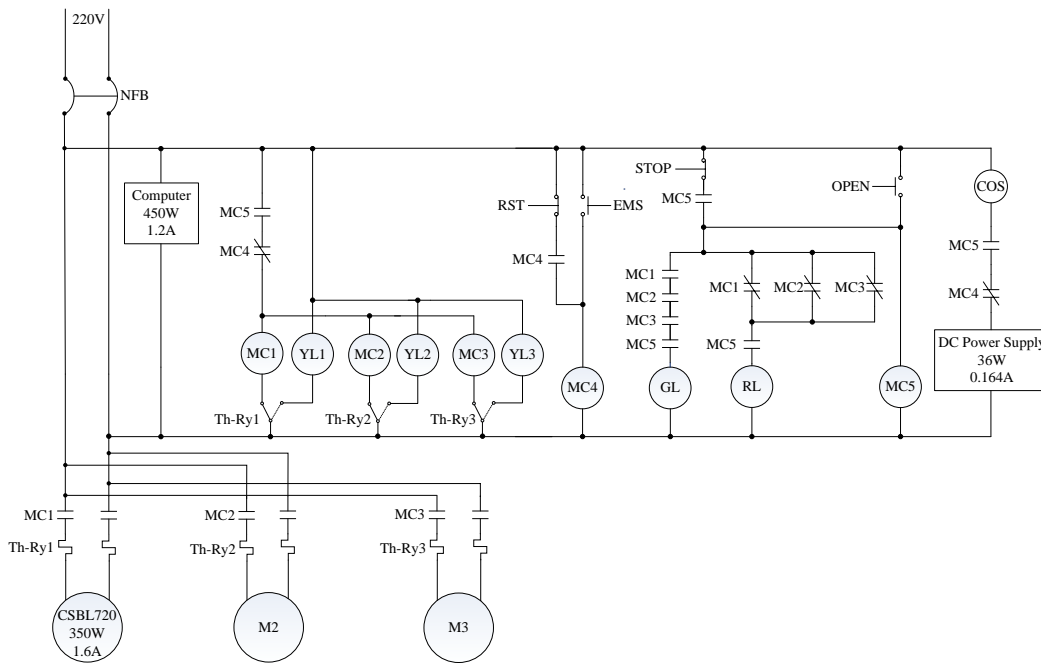

FIG. 3. THE WIRING DIAGRAM OF MOTORS.

3.1.3 Mechanical system

The mechanical structure configuration is shown in Fig. 4 (a)-(c). It is actually the front, side, and plane views of the proposed delta robot, respectively. We use the SolidWorks software to design the mechanical structure of the delta robot.

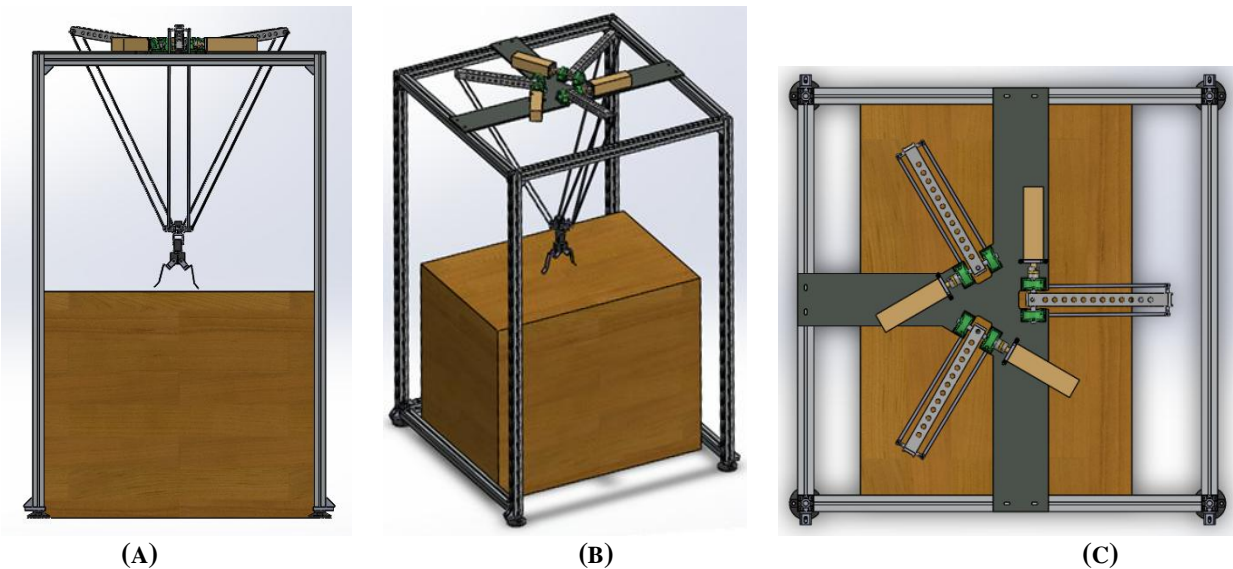

FIG. 4. THE MECHANICAL SYSTEM CONFIGURATION. (A) FRONT VIEW, (B) SIDE VIEW, (C) PLAN VIEW.

3.2 System Performances

The performance demonstration of this work can also be divided into the software control and the overall performance.

3.2.1 Software control

As shown in Fig. 5, we use Visual Studio C# to develop the human-robot interface platform, where each function of the interface is introduced as the follows.



FIG. 5. THE MONITOR PLATFORM OF THE HUMAN-MACHINE INTERFACE.

3.2.2 Stage execution region

The region totally contains four buttons. As long as any button is pushed, it will execute the strategy of the corresponding stage.

3.2.3 Machine test region

The region is employed to test and correct the parameters of the mechanical arms. It provides users to enter the values of the position of under-platform and the angles of serial arm, and the parameters will be obtained as a result.

3.2.4 Reset and stop region

In this region, we set several buttons for reset and stop the mechanical arms. If the user pushes the reset button, the mechanical arms will return to the initial state. Similarly, if the user pushes the stop button, the mechanical arms will be forced to stop immediately if there is something occurs emergently.

3.2.5 Monitor region

This region will monitor the information returned by each motor at any time, including the position, angular velocity, the temperature, etc. It will also return the position of under-platform at the same time.

3.2.6 Computer vision region

This region provides a real-time image monitor captured from a webcam equipped on top of the delta robot. Buttons are designed for turning on the webcam, binarizing the image, displaying and saving the image.

3.2.7 Overall performance

The overall delta robot is shown in Fig. 6 (From the top to the bottom are the three-axis motors, three-axis upper arms, parallel link, under-platform, and the serial arm). It is worth to note that the materials that construct the structure of the delta robot is the aluminum to reduce the weights and the mechanical inertia.

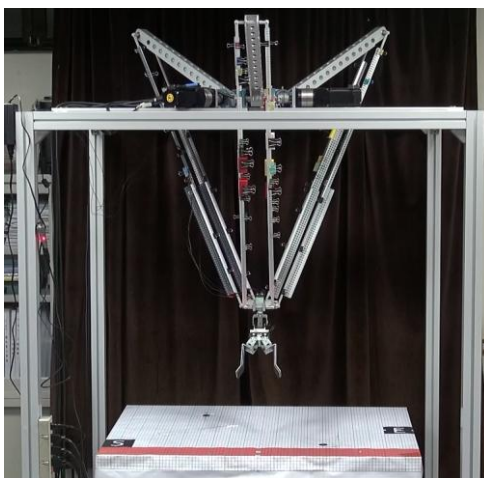

FIG. 6. THE ACTUAL MECHANICAL ARM.

IV. EXPERIMENTAL RESULTS

To verify the overall performances of the proposed delta robot, drawing pictures, objects classification, and playing dominoes are provided. As shown in Fig. 7, we control the mechanical arms to arrange the dominoes. The corresponding flowchart is shown in Fig. 8. As for drawing and writing words, the result is shown in Fig. 9, and the corresponding flowchart is shown in Fig. 10. As shown in Fig. 11, we control the mechanical arm to grip objects and classify them based on their shapes and colors. The corresponding flowchart is shown in Fig. 12.

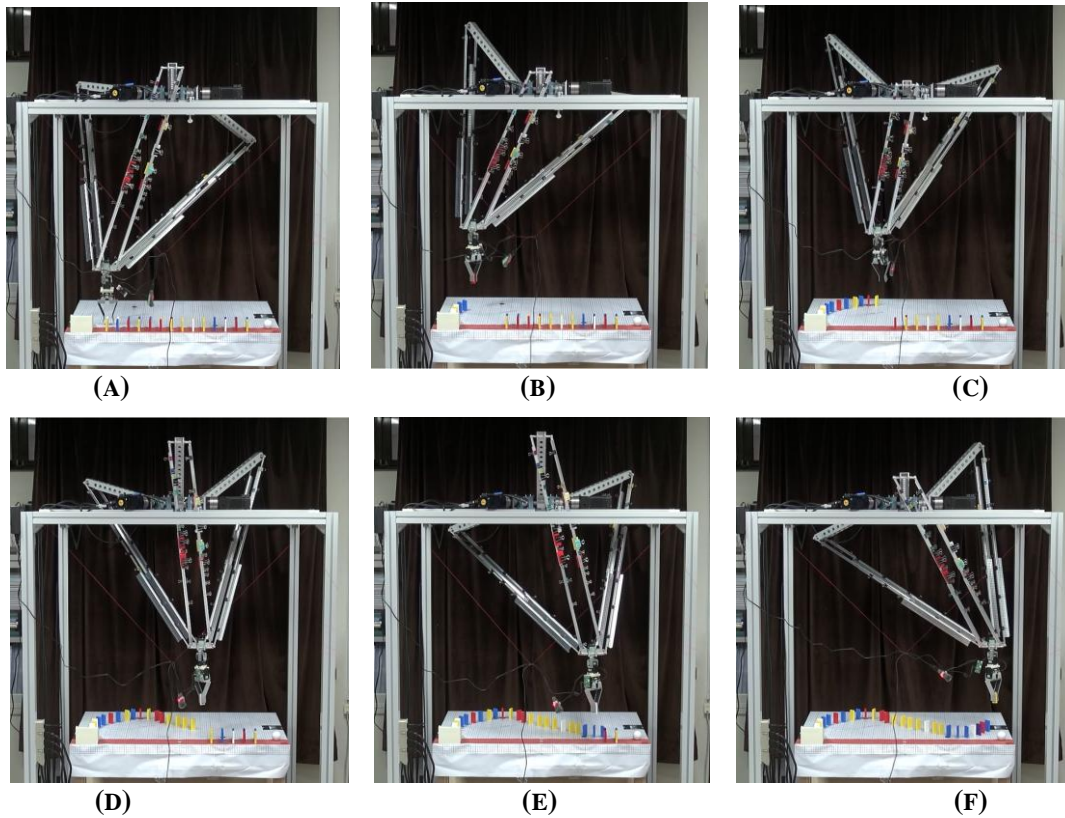

FIG. 7. THE IMAGES ORDER OF DOMINOES ARRANGING.

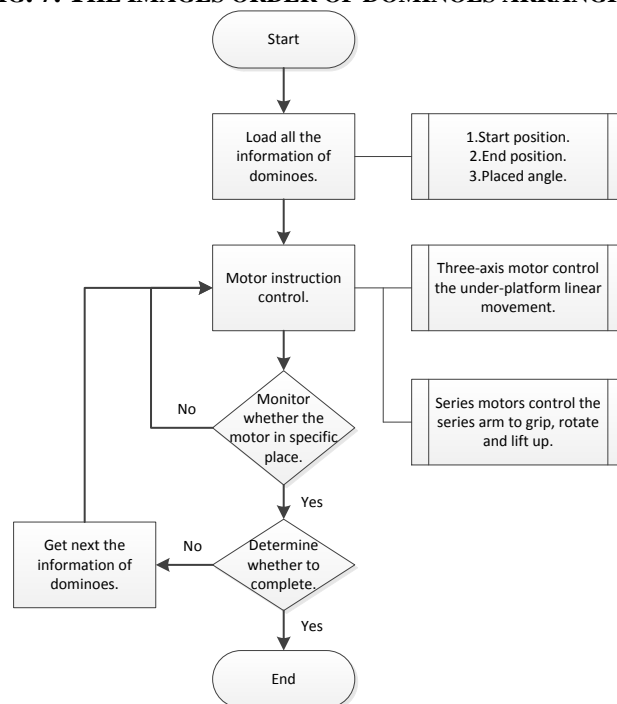

FIG. 8. THE FLOWCHART OF DOMINOES ARRANGING.

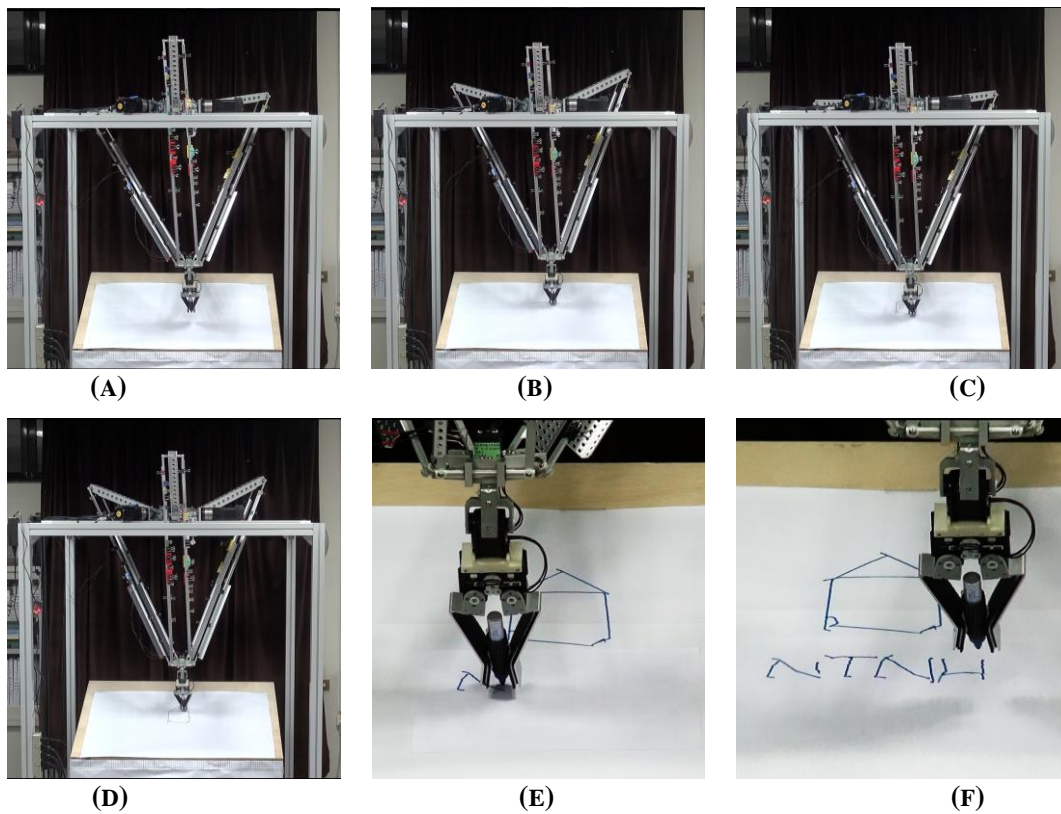

FIG. 9. THE IMAGES ORDER OF DRAWING AND WORDS WRITING.

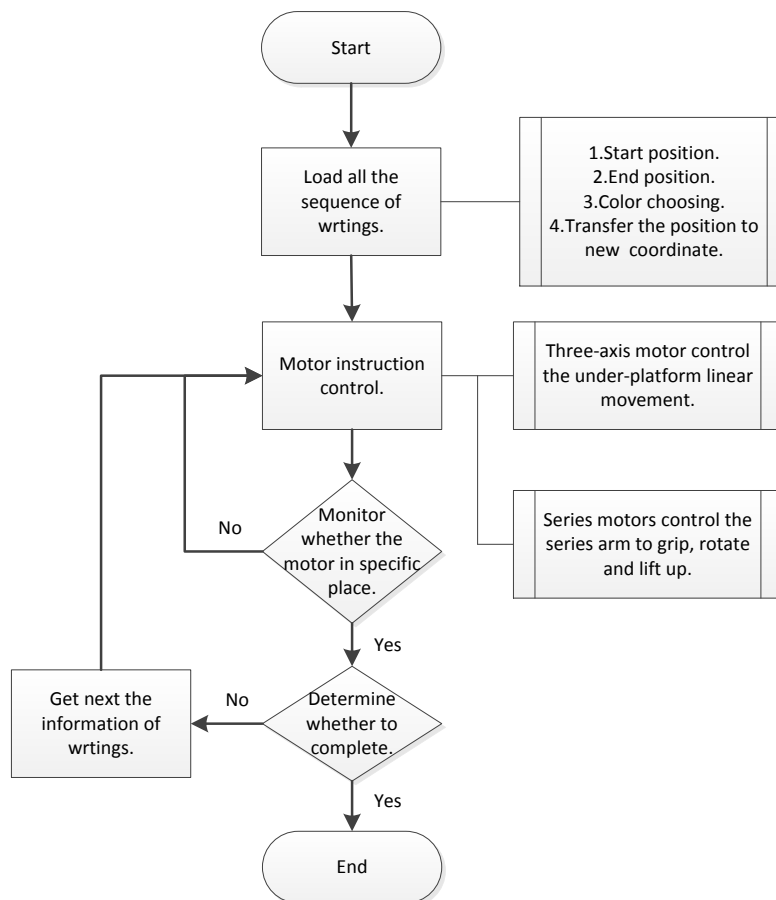

FIG. 10. THE FLOWCHART OF PICTURE DRAWING AND WORD WRITING.

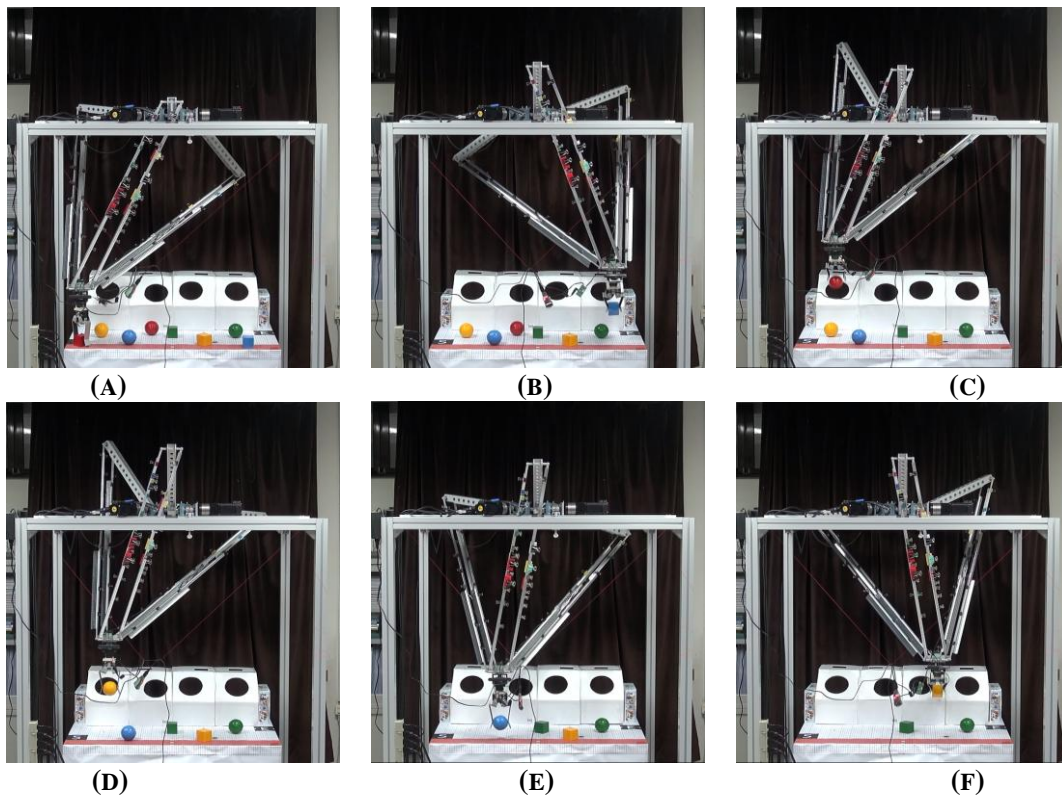

FIG. 11. THE IMAGES ORDER OF OBJECTS CLASSIFICATION.

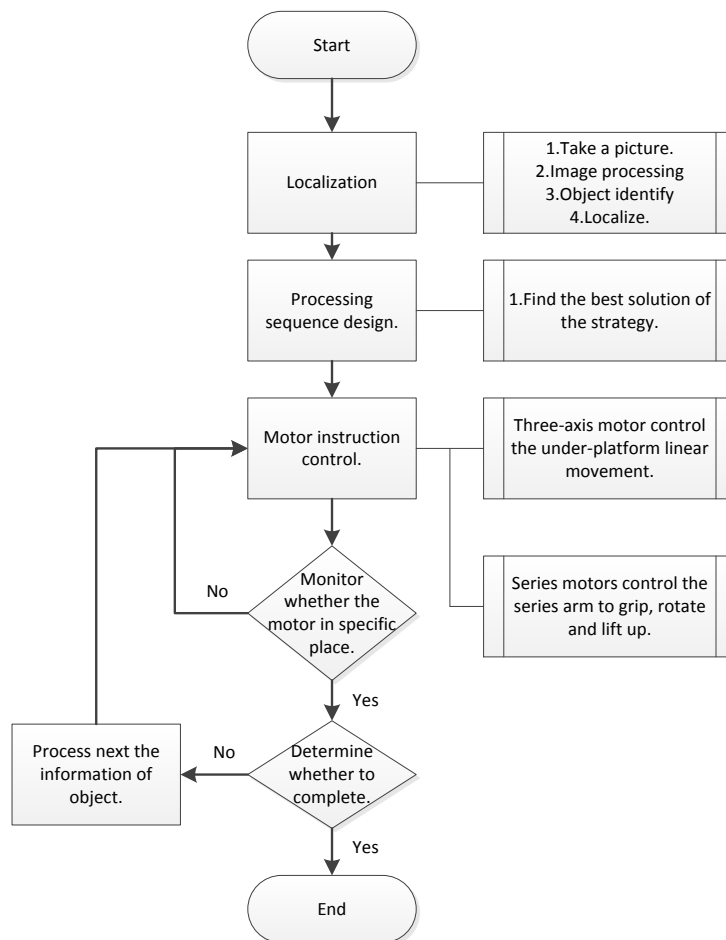

FIG. 12. THE FLOWCHART OF OBJECTS CLASSIFICATION.

V. RESULT DISCUSSIONS

Our design of the delta robot emphasizes on the combinations of serial and parallel robotic arms, which provides the advantages of faster velocity, better accuracy and less dynamic errors. As for the joint design of our delta robot, we use spherical bearings to substitute the traditional ball joints. Thus this provides three differences as follows: (1) Higher accuracies compared to the ball joints. (2) Increases in the operating range of the robot. (3) More durable compared to the ball joints. Because of these characteristics, we can make our robot more stable and more reliable. Besides, we've been focusing on improving the mechanical strengths and decreasing the mass of the arms without worsening its performances. It is important to design the mechanical components so as to enhance the overall performances and stabilities.

VI. CONCLUSIONS

In this paper, a novel design of a robot with delta-like architecture is proposed. By using the forward kinematics and the inverse kinematics to analyze serial-parallel mechanical arms, the proposed delta robot becomes more stable and reliable. A Visual Studio C# based graphical user interface is established, and several functions are designed to control the proposed delta robot. It is important for the delta robot to localize accurately and efficiently, we therefore employ the spherical bearings instead of the traditional ball joints to enhance the reliability of the overall system. Finally, a set of experimental results were adequate to demonstrate the superior performance of the proposed system architecture.

ACKNOWLEDGEMENTS

This research is partially supported by the "Aim for the Top University Project 103J1A12" and "Center of Learning Technology for Chinese" of National Taiwan Normal University (NTNU), sponsored by the Ministry of Education, Taiwan, R.O.C. and the "International Research-Intensive Center of Excellence Program" of NTNU and Ministry of Science and Technology, Taiwan, R.O.C. under Grants no. MOST 104-2221-E-003-024 and MOST 104-2221-E003-026.

REFERENCES

- [1] R. Clavel, "Device for the movement and positioning of an element in space," US Patent No. 4976582A, Dec. 1990.
- [2] G. Borchert, M. Battistelli, G. Runge, and A. Raatz, "Analysis of the mass distribution of a functionally extended delta robot," *Robotics and Computer-Integrated Manufacturing*, vol. 31, pp. 111–120, 2015.
- [3] M. A. Laribi, L. Romdhane, and S. Zeghloul, "Analysis and dimensional synthesis of the delta robot for a prescribed workspace," *Mechanism and Machine Theory*, vol. 42, pp. 859–870, 2007.
- [4] B. Du, Q. Ling, and S. Wang, "Improvement of the conventional computed-torque control scheme with a variable structure compensator for delta robots with uncertain load," in *Proc. of the 2014 International Conference on Mechatronics and Control (ICMC)*, July 2014, pp. 99–104.
- [5] H.-H. Lin, Y.-H. Ta, and C.-S. Liu, "The implementation of smoothing robust control for a delta robot," in *Proc. of the 2013 Second International Conference on Robot, Vision and Signal Processing*, 2013, pp. 208–213.
- [6] T. Uzunovic, E. Golubovic, E. A. Baran, and A. Sabanovic, "Configuration space control of a parallel delta robot with a neural network based inverse kinematics," in *Proc. of the 2013 8th International Conference on Electrical and Electronics Engineering (ELECO)*, 2013, pp. 497–501.
- [7] J. Brinker and B. Corves, "A survey on parallel robots with delta-like architecture," in *Proc. of the 14th IFToMM World Congress*, Oct. 2015, pp. 407–414.
- [8] Y. Zhang, R. Huang, Y. Lou, and Z. Li, "Dynamics based time-optimal smooth motion planning for the delta robot," in *Proc. of the 2012 IEEE International Conference on Robotics and Biomimetics*, Dec. 2012, pp. 11–14.
- [9] F. Pierrot, C. Reynaud, and A. Fournier, "DELTA: a simple and efficient parallel robot," *Robotica*, vol. 8, no. 2, pp. 105–109, 1990.
- [10] S. Ji, G. Wang, Z. Wang, Y. Wan, and Q. Yuan, "Optimal design of a linear delta robot for the prescribed regular-shaped dexterous workspace," in *Proc. of the 7th World Congress on Intelligent Control and Automation*, June 2008, pp. 2333–2338.
- [11] A. Codourey, R. Clavel, and C. W. Burckhardt, "Control algorithm and controller for the direct drive delta robot," in *Proc. of the 3rd IFAC/IFIP/IMACS Symposium*, Sept. 1992, pp. 543–549.
- [12] I. Simionescu, L. Ciupitu, and L. C. Ionita, "Static balancing with elastic systems of delta parallel robots," *Mechanism and Machine Theory*, vol. 87, pp. 150–162, May 2015.
- [13] R. Kelaiaia, O. Company, and A. Zaatri, "Multiobjective optimization of a linear delta parallel robot," *Mechanism and Machine Theory*, vol. 50, pp. 159–178, April 2012.
- [14] L. A. Castañeda, A. Luviano-Juárez, and I. Chairez, "Robust trajectory tracking of a delta robot through adaptive active disturbance rejection control," *IEEE Trans. on Control Systems Technology*, vol. 23, no. 4, pp. 1387–1398, 2015.
- [15] P. Guglielmetti and R. Longchamp, "Task space control of the delta parallel robot," *Motion Control for Intelligent Automation*, pp. 337–342, Oct. 1992.

-
- [16] X. Lu and M. Liu, "A fuzzy logic controller tuned with PSO for delta robot trajectory control," in *Proc. of the 41st Annual Conference of the IEEE Industrial Electronics Society*, Nov. 2015, pp. 4345–4351.
- [17] V. Poppeova, J. Uricek and V. Bulej "The development of mechanism based on hybrid kinematic structure," *MM Science Journal*, vol. 1, pp. 228–231, 2011.
- [18] U. Thomas, I. Maciuszek, and F. M. Wahl, "A unified notation for serial, parallel, and hybrid kinematic structures," in *Proc. of the IEEE International Conference on Robotics and Automation*, vol. 3, 2002, pp. 2868–2873.
- [19] C. R. Boër, L. Molinari-Tosatti, and K. S. Smith, *Parallel Kinematic Machines: Theoretical Aspects and Industrial Requirements*, Springer-Verlag London, 1999.
- [20] L.-W. Tsai, *Robot analysis: the mechanics of serial and parallel manipulators*, John Wiley & Sons, Inc, 1999.